

8

- SD2 Triangle**

- SD3 Triangle**

- SR1 Circular**

- SR1S Circular, movable**

- SR2 Circular**

- SDP2 Triangle Roof Lights**

- SDP3 Triangle Roof Lights**



SD 2 Triangle, SD 3 Triangle / SR 1 Half Circular Panel, SR 2 Quarter Circular Panel

SD 2 fixed

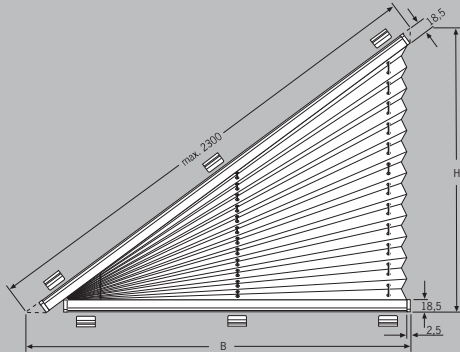

 **Fitting Situation:**
Vertical

SR 1 fixed
half width = radius

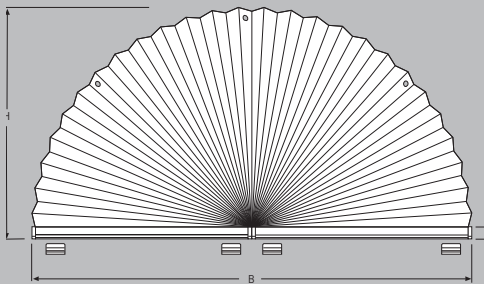

 **Fitting Situation:**
Vertical

SD 3 fixed

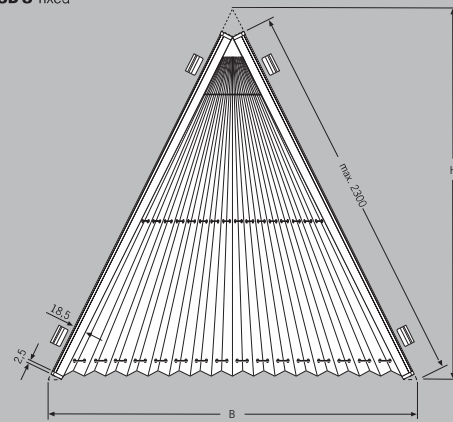

 **Fitting Situation:**
Vertical

dimensions in mm

SR 2 fixed
width = radius

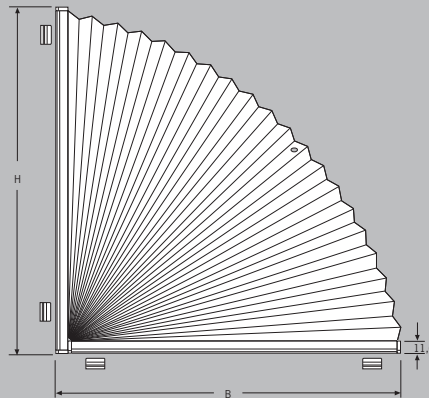

 **Fitting Situation:**
Vertical

dimensions in mm

Operation:

Fixed Position

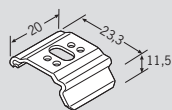

Top Fix Bracket
48100 silver
48101 white
48102 black

Size Ranges

SD 2:
max. dimensions
max. width (B) 160 cm*
max. height (H) 160 cm

min. dimensions
min. width (B) 20 cm
min. height (H) 20 cm

*depending on fabric width

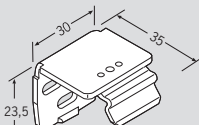

Face Fix Bracket
48200 grey
48201 white
48202 black

Size Ranges

SD 3:
max. dimensions
max. width (B) 200 cm
max. height (H) 200 cm
max. slope 230 cm*

min. dimensions
min. width (B) 20 cm
min. height (H) 20 cm

*depending on fabric width

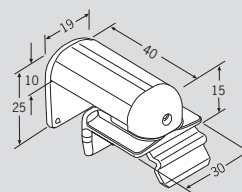

Clamp Bracket
48300 grey
48301 white
48302 black

Size Ranges

SR 1:
max. dimensions
max. width (B) 150 cm*
max. height (H) 75 cm

min. dimensions
min. width (B) 30 cm
min. height (H) 15 cm

SR 2:
max. dimensions
max. width (B) 100 cm
max. height (H) 100 cm

min. dimensions
min. width (B) 15 cm
min. height (H) 15 cm

*depending on fabric width

SDP 2 Triangle, SDP 3 Triangle

SDP 2 fixed

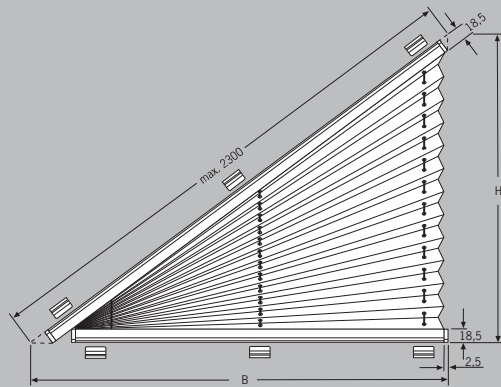

 **Fitting Situations:**
Angled / Horizontal

SDP 3 fixed

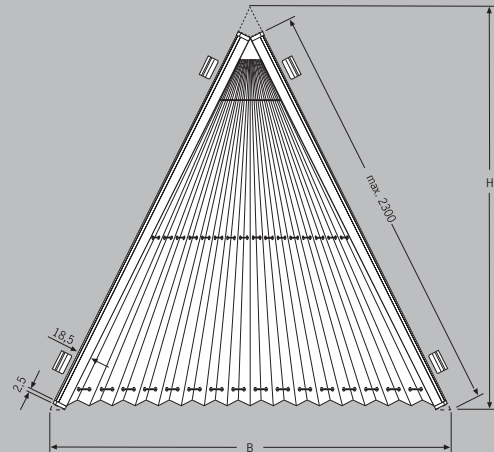

 **Fitting Situations:**
Angled / Horizontal

dimensions in mm

Operation:

Fixed Position

Size Ranges

SDP 2:

max. dimensions	
max. width (B)	160 cm*
max. height (H)	160 cm
min. dimensions	
min. width (B)	20 cm
min. height (H)	20 cm

*depending on fabric width

Size Ranges

SDP 3:

max. dimensions	
max. width (B)	200 cm*
max. height (H)	200 cm
max. slope	230 cm*
min. dimensions	
min. width (B)	20 cm
min. height (H)	20 cm

*depending on fabric width

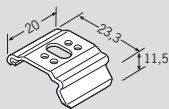

Top Fix Bracket

- 48100 silver
- 48101 white
- 48102 black

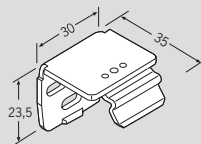

Face Fix Bracket

- 48200 grey
- 48201 white
- 48202 black

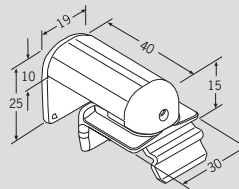

Clamp Bracket

- 48300 grey
- 48301 white
- 48302 black

Shaped Blinds

When ordering these blinds, please supply a dimension drawing with all required blind sizes.

For round blinds, please supply a template on scale of 1:1.

Attention:

**If Not Specified:
Fabric Width = Rail Width
End Caps Overlap!**

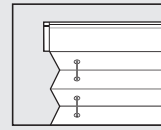

SD 2: width, height, slope

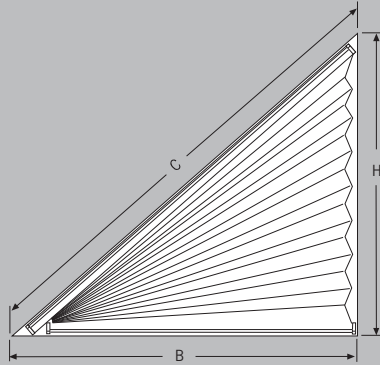

SD 3: width, height, slope left, slope right

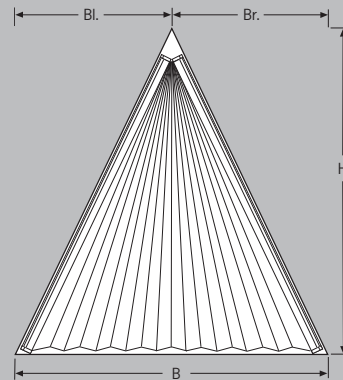

SR 1: width, height (radius = half width)

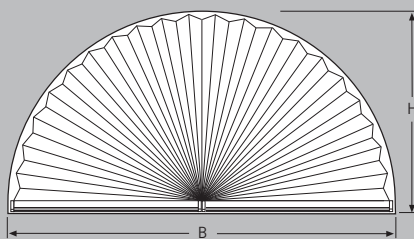

SR 2: width, height

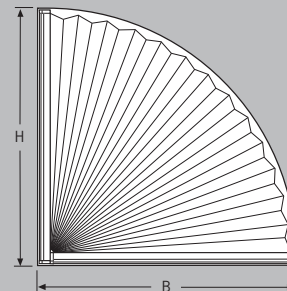

Distance Between Blind and Window Pane = 5 mm

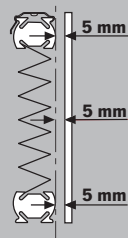

SDP 2: width, height, slope

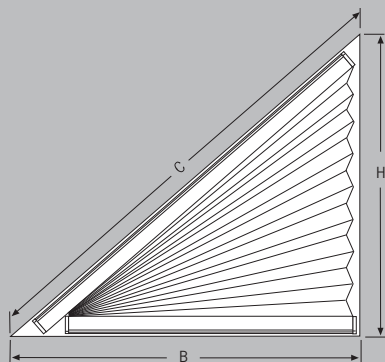

SDP 3: width, height, slope left, slope right

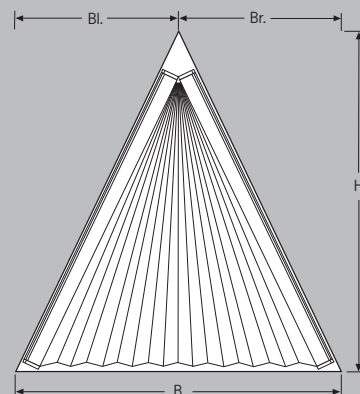

Minimum distance to window pane for roof blinds is 100 mm.

SR1S Half Circular Panel

SR1S

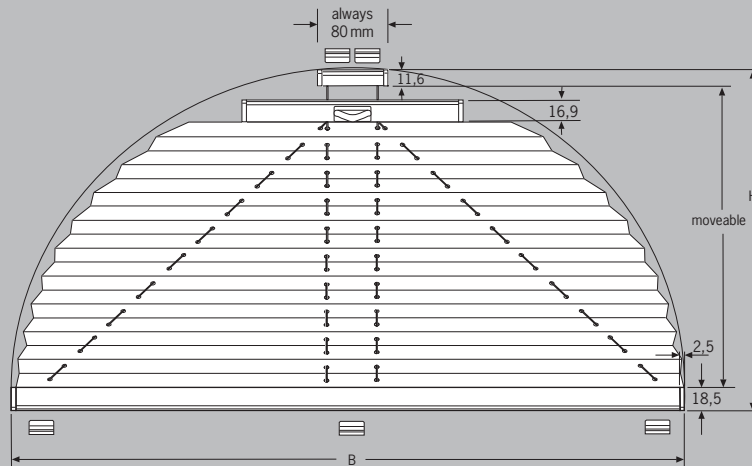

 **Fitting Situation:**
Vertical

dimensions in mm

Operation (please specify):

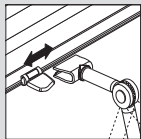

Operating rod with or without joint

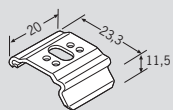

Top Fix Bracket

48100 silver
48101 white
48102 black

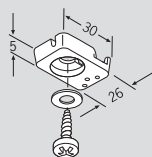

Holder SR1S

48260 grey
48261 white
48262 black

Size Ranges SR1S:

max. dimensions
max. width (B) 150 cm
max. height (H) 150 cm

min. dimensions
min. width (B) 30 cm
min. height (H) 30 cm

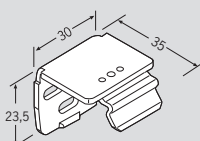

Face Fix Bracket

48200 grey
48201 white
48202 black

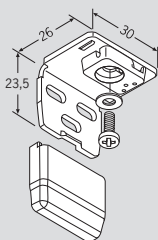

Face Fix Bracket SR1S

48263 grey
48264 white
48265 black

SR1S

Blind Height:

50 cm
100 cm
150 cm

Package Height:

ca. 5 cm
ca. 6 cm
ca. 7 cm

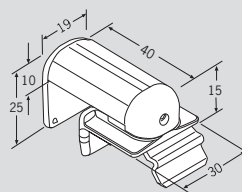

Clamp Bracket

48300 grey
48301 white
48302 black

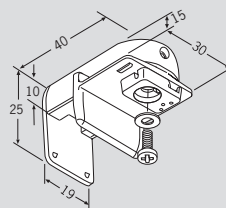

Clamp Bracket SR1S

48266 grey
48267 white
48268 black

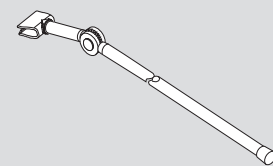

Operating Rod with Joint

48504 125 cm
48505 150 cm
48506 200 cm
48507 250 cm

SR1S

When ordering these blinds, please supply a dimension drawing with all required blind sizes.

For round blinds, please supply a template on scale of 1:1.

SR1S

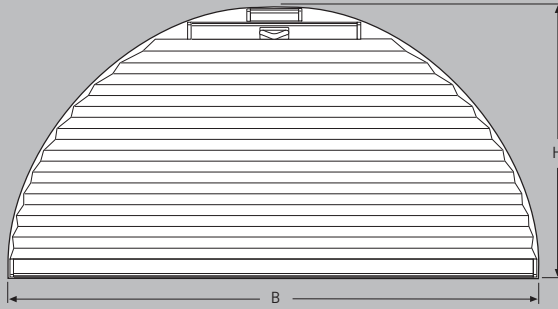

Distance Between Blind and Window Pane = 5 mm

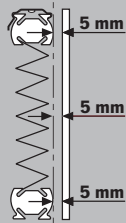

Attention:

If Not Specified:
Fabric Width = Rail width
End Caps Overlap!

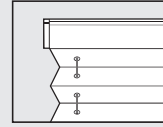

SR1S

Top- and Bottom Rail

Aluminium rails, silver anodised, white coated, black-brown coated or brass anodised.

Fitting Situation: Vertical

